

JVC



ENGLISH

DEUTSCH

FRANÇAIS

NEDERLANDS

CD RECEIVER
CD-RECEIVER
RECEPTEUR CD
CD-RECEIVER

KD-S811R/KD-S713R/ KD-S711R



KD-S811R

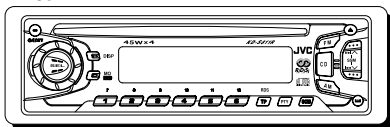

KD-S713R

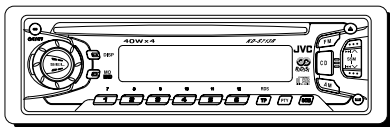

KD-S711R

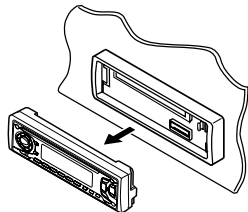
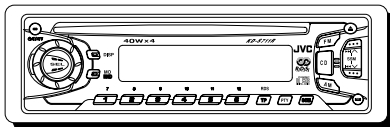

COMPACT
disc
DIGITAL AUDIO

For installation and connections, refer to the separate manual.
Für den Einbau und die Anschlüsse siehe das eigenständige Handbuch.
Pour l'installation et les raccordements, se référer au manuel séparé.
Bijzonderheden over de installatie en aansluiting van het apparaat vindt u in de desbetreffende handleiding.

INSTRUCTIONS **BEDIENUNGSANLEITUNG** **MANUEL D'INSTRUCTIONS** **GEbruIKSAANWIJZING**

Position And Reproduction Of Labels

Bottom panel of the main unit

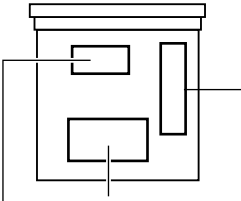

Name/Rating plate

DANGER: Invisible laser radiation when open and interlock failed or defeated. AVOID DIRECT EXPOSURE TO BEAM. (e)	ADVARSEL: Usynlig laserstråling ved åbning, når sikkerhedsafbrydere er ude af funktion. Undgåudsættelse for stråling. (d)	WARNING: Osynlig laserstråling når denne del är öppnad och spärren är urkopplad. Beträkta ej strålen. (s)	VARO: Avattaessa ja suojalukitus ohitettaessa olet alltiina näkymättömälle lasersäteilylle. Älä katso säteeseen. (f)
--	--	--	---

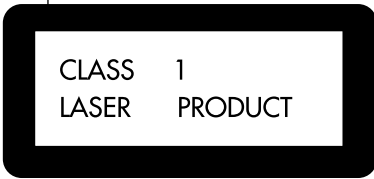

Caution:

This product contains a laser component of higher laser class than Class 1.

IMPORTANT FOR LASER PRODUCTS

Precautions:

- CLASS 1 LASER PRODUCT**
- DANGER:** Invisible laser radiation when open and interlock failed or defeated. Avoid direct exposure to beam.
- CAUTION:** Do not open the top cover. There are no user-serviceable parts inside. Leave all servicing to qualified service personnel.
- CAUTION:** This CD player uses invisible laser radiation and is equipped with safety switches to prevent radiation emission when unloading CDs. It is dangerous to defeat the safety switches.
- CAUTION:** Use of controls, adjustments or performance of procedures other than those specified herein may result in hazardous radiation exposure.

How to reset your unit

Press and hold both the SEL (select) and I/ATT (standby/on/attenuator) buttons at the same time for several seconds.

This will reset the built-in microcomputer.

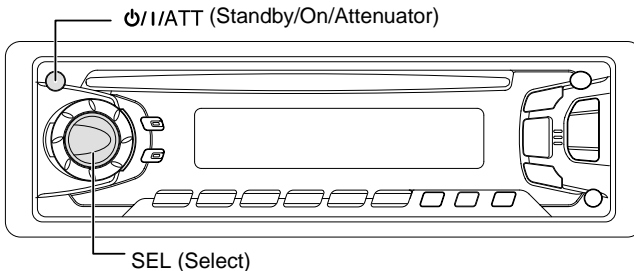

Notes:

- Your preset adjustments — such as preset channels or sound adjustments — will also be erased.
- If a CD is in the unit, it will eject when you reset the unit. Pay attention not to drop the CD.

Thank you for purchasing a JVC product. Please read all instructions carefully before operation, to ensure your complete understanding and to obtain the best possible performance from the unit.

CONTENTS

How to reset your unit	2	SOUND ADJUSTMENTS	17
LOCATION OF THE BUTTONS	4	Adjusting the sound	17
Control panel	4	Using the	
BASIC OPERATIONS	5	Sound Control Memory (SCM)	17
Turning on the power	5	Storing your own sound adjustments	18
RADIO BASIC OPERATIONS	6	OTHER MAIN FUNCTIONS	19
Listening to the radio	6	Setting the clock	19
Storing stations in memory	7	Changing the general settings (PSM)	19
Tuning into a preset station	8	Detaching the control panel	22
RDS OPERATIONS	9	REMOTE CONTROLLER	23
What you can do with RDS EON	9	(With an optionally purchased remote	
Other convenient RDS functions and		controller) (only for KD-S811R)	
adjustments	12	Installing the battery	23
CD OPERATIONS	14	Using the remote controller	24
Playing a CD	14	TROUBLESHOOTING	25
Locating a track or a particular portion on a		MAINTENANCE	26
CD	15	Handling CDs	26
Selecting CD playback modes	15	SPECIFICATIONS	27
Prohibiting CD ejection	16		

Note:

For security reasons, a numbered ID card is provided with this unit, and the same ID number is imprinted on the unit's chassis. Keep the card in a safe place, as it will help the authorities to identify your unit if stolen.

BEFORE USE

***For safety...**

- Do not raise the volume level too much, as this will block outside sounds, making driving dangerous.
- Stop the car before performing any complicated operations.

***Temperature inside the car...**

If you have parked the car for a long time in hot or cold weather, wait until the temperature in the car becomes normal before operating the unit.



LOCATION OF THE BUTTONS

ENGLISH

Control panel

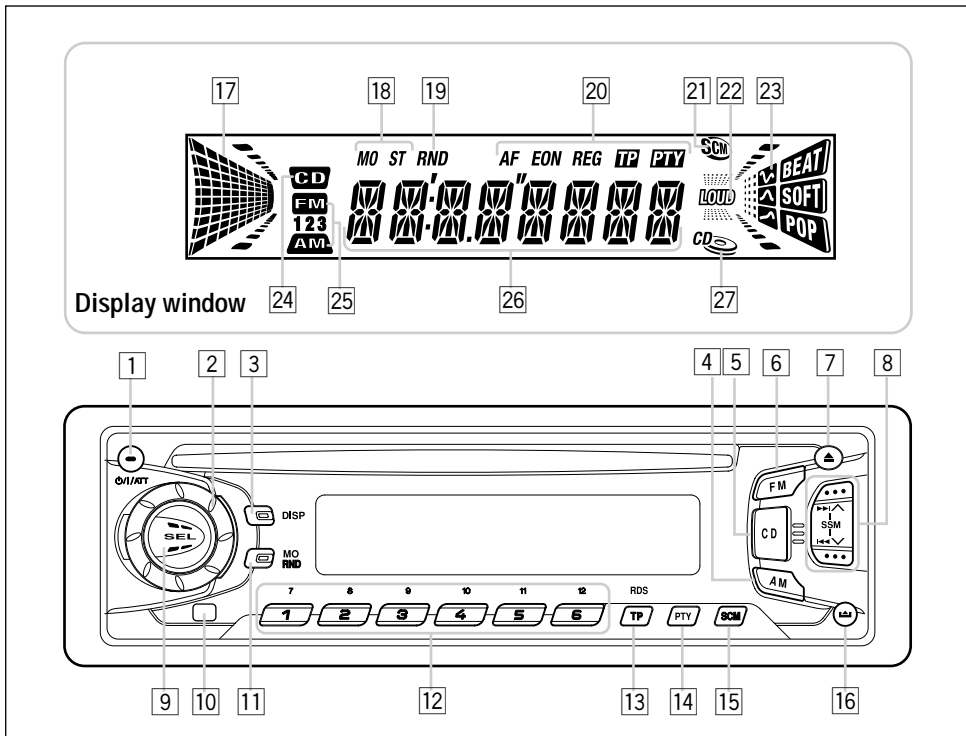

- 1 **⏻/I/ATT** (standby/on/attenuator) button
- 2 **Control dial**
- 3 **DISP** (display) button
- 4 **AM** button
- 5 **CD** button
- 6 **FM** button
- 7 **▲** (eject) button
- 8 **◀◀▶▶▶▶▲** buttons
 - Also functions as **SSM** buttons when pressed together.
- 9 **SEL** (select) button
- 10 **Remote sensor** (only for KD-S811R)
- 11 **MO** (monaural) button
RND (random) button
- 12 **Number buttons**
- 13 **TP** (traffic programme)
RDS (radio data system) button
- 14 **PTY** (programme type) button
- 15 **SCM** (sound control memory) button
- 16 **▶** (control panel release) button

Display window

- 17 **Volume** (or audio) level indicator
Equalization Pattern indicator
- 18 **Tuner reception** indicators
STEREO, **MONO**
- 19 **RND** (random) indicator
- 20 **RDS** indicators
AF, **EON**, **REG**, **TP**, **PTY**
- 21 **"SCM"** indicator
- 22 **LOUD** indicator
- 23 **Sound mode** indicators
BEAT, **SOFT**, **POP**
- 24 **CD** indicator
- 25 **Band** indicators
FM1, **FM2**, **FM3**
AM
- 26 **Main display**
- 27 **CD IN** indicator

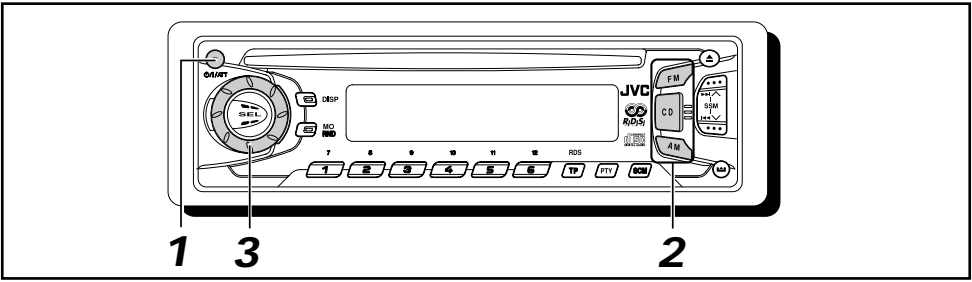

Turning on the power

1 Turn on the power.



Note on One-Touch Operation:

When you select a source in step 2 below, the power automatically comes on. You do not have to press this button to turn on the power.

2 Select the source.

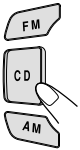

To operate the tuner (AM or FM), see pages 6 – 13.

To operate the CD player, see pages 14 – 16.

3 Adjust the volume.

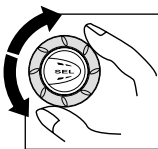

To increase the volume.

To decrease the volume.

Volume level indicator



Volume level appears.

4 Adjust the sound as you want (see page 17.)

To drop the volume in a moment

Press **PH/ATT** briefly while listening to any source. "ATT" starts flashing on the display, and the volume level will drop in a moment.

To resume the previous volume level, press the button briefly again.

- If you rotate the control dial clockwise, you can also restore the sound.

To turn off the power

Press and hold **PH/ATT** for more than 1 second.

Note:

When you use this unit for the first time, set the built-in clock correctly, see page 19.

CAUTION on Volume Setting

CDs produce very little noise compared with other sources. If the volume level is adjusted for the tuner, for example, the speakers may be damaged by the sudden increase in the output level. Therefore, lower the volume before playing a disc and adjust it as required during playback.



RADIO BASIC OPERATIONS

ENGLISH

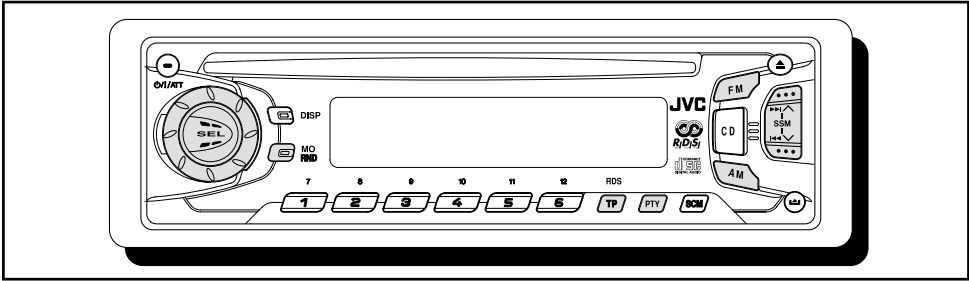

Listening to the radio

You can use either automatic searching or manual searching to tune into a particular station.

Searching a station automatically: Auto search

- 1 Select the band (AM, FM1 – 3).

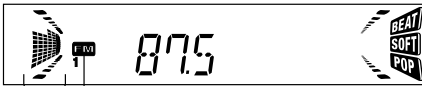
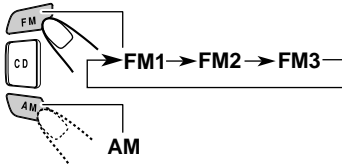

Selected band appears.

Audio (see page 21) or volume level indicator

Note:

This receiver has three FM bands (FM1, FM2, FM3). You can use any one of them to listen to an FM broadcast.

- 2 Start searching a station.

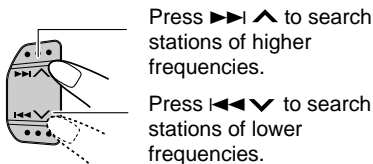

Press \blacktriangleright \blacktriangle to search stations of higher frequencies.

Press \blacktriangleleft \blacktriangledown to search stations of lower frequencies.

When a station is received, searching stops.

To stop searching before a station is received, press the same button you have pressed for searching.

Searching a station manually: Manual search

- 1 Select the band (AM, FM1 – 3).

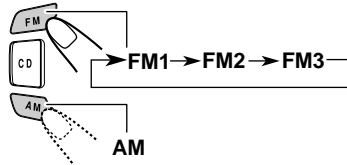

Note:

This receiver has three FM bands (FM1, FM2, FM3). You can use any one of them to listen to an FM broadcast.

- 2 Press and hold \blacktriangleright \blacktriangle or \blacktriangleleft \blacktriangledown until "M" (manual) starts flashing on the display.

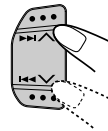

Selected band appears.

3 Tune into a station you want while “M” is flashing.

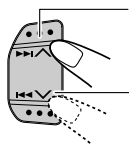

Press **▶▶ ▲** to search stations of higher frequencies.

Press **◀◀ ▼** to search stations of lower frequencies.

- If you release your finger from the button, the manual mode will automatically turn off after 5 seconds.
- If you hold down the button, the frequency keeps changing (in 50 kHz intervals for FM and 9 kHz intervals for AM – MW/LW) until you release the button.

Storing stations in memory

You can use one of the following two methods to store broadcasting stations in memory.

- Automatic preset of FM stations: SSM (Strong-station Sequential Memory)
- Manual preset of both FM and AM stations

FM station automatic preset: SSM

You can preset 6 local FM stations in each FM band (FM1, FM2 and FM3).

1 Select the FM band (FM1 – 3) you want to store FM stations into.

- Each time you press the button, the FM band changes as follows:

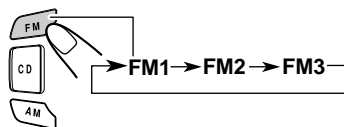

2 Press and hold both buttons for more than 2 seconds.

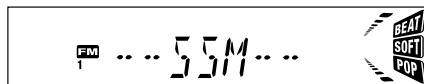
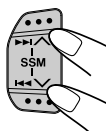

“SSM” appears, then disappears when automatic preset is over.

Local FM stations with the strongest signals are searched and stored automatically in the band number you have selected (FM1, FM2 or FM3.) These stations are preset in the number buttons — No.1 (lowest frequency) to No.6 (highest frequency). When automatic preset is over, the station stored in number button 1 will be automatically tuned in.

When an FM stereo broadcast is hard to receive:

Press **MO RND** (monaural/random) while listening to an FM stereo broadcast.

- Each time you press the button, the **MO** indicator lights up and goes off alternately.

Lights up when receiving an FM broadcast in stereo.

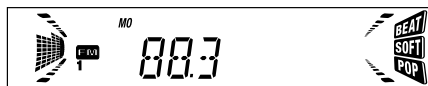
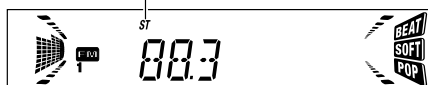

When the **MO** indicator is lit on the display, the sound you hear becomes monaural but the reception will be improved (the **ST** indicator goes off).



Manual preset

You can preset up to 6 stations in each band (FM1, FM2, FM3 and AM) manually.

Ex: Storing an FM station of 88.3 MHz into the preset number 1 of the FM1 band

1 Select the FM band (FM1 – 3) you want to store FM stations into (in this example, FM1).

- Each time you press the button, the FM band changes as follows:

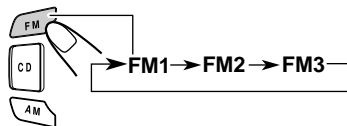

2 Tune into a station of 88.3 MHz.

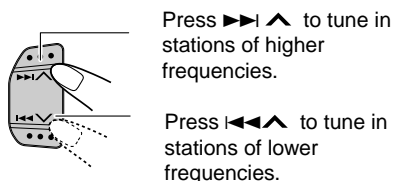

3 Press and hold the number button (in this example, 1) for more than 2 seconds.

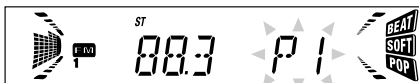

"P1" flashes for a few seconds.

4 Repeat the above procedure to store other stations into other preset numbers.

Notes:

- A previously preset station is erased when a new station is stored in the same preset number.
- Preset stations are erased when the power supply to the memory circuit is interrupted (for example, during battery replacement). If this occurs, preset the stations again.

Tuning into a preset station

You can easily tune into a preset station. Remember that you must store stations first. If you have not stored them yet, see "Storing stations in memory" on page 7.

1 Select the band (AM, FM1 – 3).

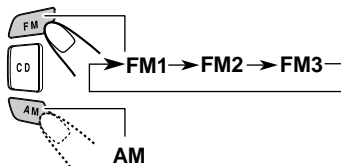

2 Select the number (1 – 6) for the preset station you want.

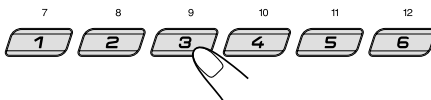



What you can do with RDS EON

RDS (Radio Data System) allows FM stations to send an additional signal along with their regular programme signals. For example, the stations send their station names, as well as information about what type of programme they broadcast, such as sports or music, etc.

Another advantage of RDS function is called "EON (Enhanced Other Networks)." The EON indicator lights up while receiving an FM station with the EON data. By using the EON data sent from a station, you can tune into a different station of a different network broadcasting your favorite programme or traffic announcement while listening to another programme or to another source such as CD.

By receiving the RDS data, this unit can do the following:

- Tracing the same programme automatically (Network-Tracking Reception)
- Standby Reception of TA (Traffic Announcement) or your favorite programme
- PTY (Programme Type) search
- Programme search
- And some other functions

Tracing the same programme automatically (Network-Tracking Reception)

When driving in an area where FM reception is not good, the tuner built in this unit automatically tunes into another RDS station, broadcasting the same programme with stronger signals. So, you can continue to listen to the same programme in its finest reception, no matter where you drive. (See the illustration on the next page.)

Two types of the RDS data are used to make Network-Tracking Reception work correctly — PI (Programme Identification) and AF (Alternative Frequency.)

Without receiving these data correctly from the RDS station you are listening to, Network-Tracking Reception will not operate.

To use **Network-Tracking Reception**, press and hold TP RDS (Traffic Programme/Radio Data System) for more than 1 second. Each time you press and hold the button, Network-Tracking Reception modes change as follows:

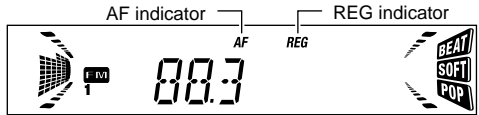
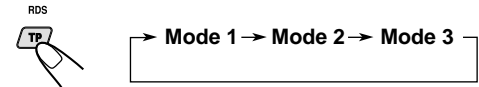

Mode 1

The AF indicator lights up but the REG indicator does not.

Network-Tracking Reception is activated with Regionalization set to "off."

Switches to another station within the same network when the receiving signals from the current station become weak.

- *In this mode, the programme may differ from the one currently received.*

Mode 2

Both the AF indicator and the REG indicator light up.

Network-Tracking Reception is activated with Regionalization set to "on."

Switches to another station, within the same network, broadcasting the same programme when the receiving signals from the current station become weak.

Mode 3

Neither the AF indicator nor the REG indicator lights up.

Network-Tracking Reception is deactivated.



The same programme can be received on different frequencies.

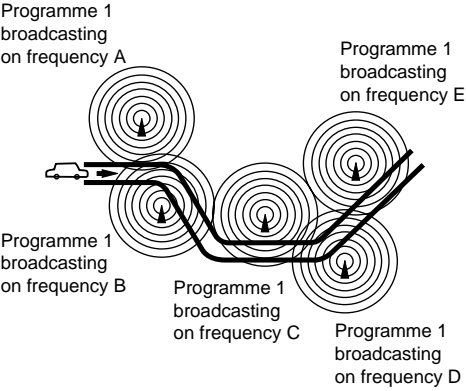

Using Standby Reception

Standby Reception allows the unit to switch temporarily to your favorite programme (PTY: Programme Type) and Traffic Announcement (TA) from the current source (another FM station and CD)

- Standby Reception will not work if you are listening to an AM station.

TA Standby Reception



When you press TP RDS while listening to an FM station, the TP indicator is lit during reception of a TP (Traffic Programme) station and the TA standby mode is engaged.

- When the station being received is not a TP station, the TP indicator flashes. Press **▶▶|▲** or **◀◀|▼** to engage the TA standby mode. "SEARCH" appears on the display, and TP station search starts. When a TP station is tuned in, the TP indicator is lit.
- If you are listening to a CD and wish to listen to a TP station, press TP RDS to enter the TA standby mode. (The TP indicator lights up.)

If a traffic programme starts broadcasting while the TA standby mode is active, "TRAFFIC" appears and the playback source changes to the FM band. The volume increases to the preset TA volume level (see page 13) and the traffic programme can be heard.

To deactivate the TA standby mode, press TP RDS again.

PTY Standby Reception



When you press PTY while listening to an FM station, the PTY indicator is lit during reception of a PTY station and the PTY standby mode is engaged. The selected PTY name stored on page 11 flashes for 5 seconds.

- When the station being received is not a PTY station, the PTY indicator flashes. Press **▶▶|▲** or **◀◀|▼** to engage the PTY standby mode. "SEARCH" appears on the display, and PTY station search starts. When a PTY station is tuned in, the PTY indicator is lit.
- If you are listening to a CD and wish to listen to a selected PTY broadcast, press PTY to enter the PTY standby mode. (The PTY indicator lights up.)

If the selected PTY programme starts broadcasting while the PTY standby mode is active, the selected PTY name appears and the playback source changes to the FM band. The selected PTY programme can then be heard.

To deactivate the PTY standby mode, press PTY again.

Selecting your favorite programme for PTY Standby Reception

You can select your favorite programme for PTY Standby Reception to store in memory. When shipped from the factory, "NEWS" is stored as the programme type for PTY Standby Reception.

- 1 Press and hold SEL (select) for more than 2 seconds so that one of the PSM items appears on the display. (PSM: see page 20.)**





2 Select "PTY STBY" (standby) if not shown on the display.

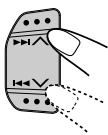

3 Select one of twenty-nine PTY codes.



Selected code name appears on the display and is stored into memory.

- For details, see the table below.

4 Finish the setting.



Searching your favorite programme

You can search one of your 6 favorite programme types stored in memory. When shipped from the factory, the following 6 programme types have been stored in the number buttons (1 to 6).

To store your favorite programme types, see below.

To search your favorite programme type, see page 12.

1	2	3
POP M	ROCK M	EASY M
4	5	6
CLASSICS	AFFAIRS	VARIED

To store your favorite programme types

- 1 Press and hold SEL (select) for more than 2 seconds so that one of the PSM items appears on the display. (PSM: see page 20.)**



CONTINUED ON THE NEXT PAGE

PTY codes

NEWS:	News
AFFAIRS:	Topical programmes expanding on current news or affairs
INFO:	Programmes which impart advice on a wide variety of topics
SPORT:	Sport events
EDUCATE:	Educational programmes
DRAMA:	Radio plays
CULTURE:	Programmes on national or regional culture
SCIENCE:	Programmes on natural science and technology
VARIED:	Other programmes like comedies or ceremonies
POP M:	Pop music
ROCK M:	Rock music
EASY M:	Easy-listening music
LIGHT M:	Light music
CLASSICS:	Classical music
OTHER M:	Other music
WEATHER:	Weather information
FINANCE:	Reports on commerce, trading, the Stock Market, etc.
CHILDREN:	Entertainment programmes for children

SOCIAL:	Programmes on social activities
RELIGION:	Programmes dealing with any aspect of belief or faith, or the nature of existence or ethics
PHONE IN:	Programmes where people can express their views either by phone or in a public forum
TRAVEL:	Programmes about travel destinations, package tours, and travel ideas and opportunities
LEISURE:	Programmes concerned with recreational activities such as gardening, cooking, fishing, etc.
JAZZ:	Jazz music
COUNTRY:	Country music
NATION M:	Current popular music from another nation or region, in that country's language
OLDIES:	Classic pop music
FOLK M:	Folk music
DOCUMENT:	Programmes dealing with factual matters, presented in an investigative style



2 Select "PTY SRCH" (search) if not shown on the display.

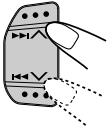

3 Select one of twenty-nine PTY codes. (See page 11.)

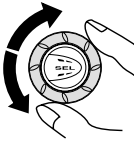

Selected code name appears on the display.

- If the code already stored in memory is selected, it will flash on the display.

4 Press and hold the number button for more than 2 seconds to store the PTY code selected into the preset number you want.

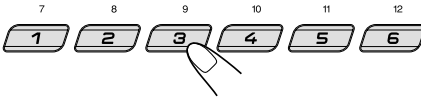

The selected code name will flash on the display.

5 Finish the setting.



To search your favorite programme type

1 Press and hold PTY (programme type) for more than 1 second while listening to an FM station.

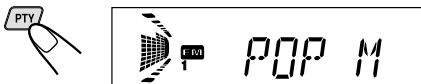

The last selected PTY code appears.

2 Select one of PTY codes stored in preset number buttons (1 to 6).

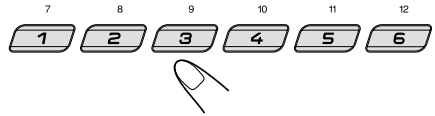

Ex. When "ROCK M" is stored in preset number button 2

PTY search for your favorite programme starts after 5 seconds.

- If there is a station broadcasting a programme of the same PTY code you selected, that station is tuned in.
- If there is no station broadcasting a programme of the same PTY code you selected, the station will not change.

Note:

In some areas, the PTY search will not work correctly.

Other convenient RDS functions and adjustments

Automatic selection of the station when using the number buttons

Usually when you press the number button, the preset station is tuned in.

However, when the preset station is an RDS station, something different will happen. If the signals from that preset station are not sufficient for good reception, this unit, using the AF data, tunes in another frequency broadcasting the same programme as the original preset station is broadcasting. (Programme search)



To activate programme search, follow the procedure below.

- Programme search takes a while.
- See also “Changing the general settings (PSM)” on page 19.

- 1 Press and hold SEL (select) for more than 2 seconds so that one of the PSM items appears on the display.
- 2 Press ►►| ▲ or |◄◄▼ to select “P(Programme)-SEARCH.”
- 3 Rotate the control dial clockwise to select “ON.”
Now programme search is activated.

To cancel programme search, repeat the same procedure and select “OFF” in step 3 by rotating the control dial counterclockwise.

Changing the display mode while listening to an FM station

You can change the initial indication on the display to station name (PS NAME), station frequency (FREQ) or Clock time (CLOCK) while listening to an FM RDS station.

- See also “Changing the general settings (PSM)” on page 19.

- 1 Press and hold SEL (select) for more than 2 seconds so that one of the PSM items appears on the display.
- 2 Press ►►| ▲ or |◄◄▼ to select “DISPMODE” (display mode).
- 3 Rotate the control dial to set to the desired indication (“PS NAME”, “FREQ” or “CLOCK”).

Note:

By pressing DISP, you can also change the display while listening to an FM RDS station.

Each time you press the button, the following information appears on the display:

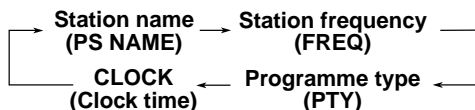

- Then, the display goes back to the original indication in several seconds.

Setting the TA volume level

You can preset the volume level for TA Standby Reception. When a traffic programme is received, the volume level automatically changes to the preset level.

- See also “Changing the general settings (PSM)” on page 19.

- 1 Press and hold SEL (select) for more than 2 seconds so that one of the PSM items appears on the display.
- 2 Press ►►| ▲ or |◄◄▼ to select “TA VOL.”
- 3 Rotate the control dial to set to the desired volume.
You can set it from “VOL 00” to “VOL 50.”

Automatic clock adjustment

When shipped from the factory, the clock built in this unit is set to be readjusted automatically using the CT (Clock Time) data in the RDS signal.

If you do not want to use automatic clock adjustment, follow the procedure below.

- See also “Changing the general settings (PSM)” on page 19.

- 1 Press and hold SEL (select) for more than 2 seconds so that one of the PSM items appears on the display.
- 2 Press ►►| ▲ or |◄◄▼ to select “AUTO ADJ.”
- 3 Rotate the control dial counterclockwise to select “OFF.”
Now automatic clock adjustment is canceled.

To reactivate clock adjustment, repeat the same procedure and select “ON” in step 3 by rotating the control dial clockwise.

Note:

It takes about 2 minutes to adjust the time using the CT data. So, you should not change the station for more than 2 minutes continuously; otherwise, the clock time will not be adjusted.



CD OPERATIONS

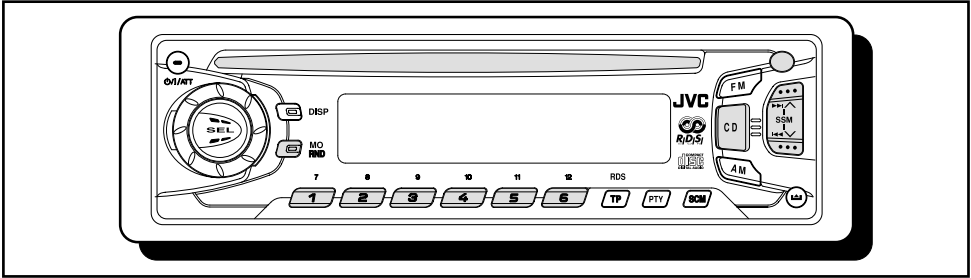

Playing a CD

1 Insert a disc into the loading slot.

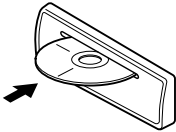

The unit turns on, draws a CD and starts playback automatically.

Note:

- When a CD is inserted upside down, the CD automatically ejects.

To stop play and eject the CD

Press ▲.

CD play stops and the CD automatically ejects from the loading slot.

If you change the source to FM or AM, the CD play also stops (without ejecting the CD this time).

Notes:

- If the ejected disc is not removed for about 15 seconds, the disc is automatically inserted again into the loading slot to protect it from dust. (CD play will not start this time.)
- You can eject the CD even when the unit is turned off.

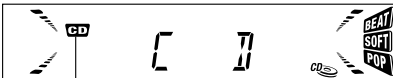
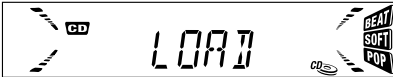

The CD IN indicator lights up.

Total playing time of the inserted disc

Total track number of the inserted disc

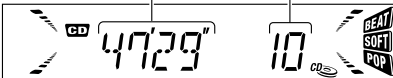

Elapsed playing time

Current track

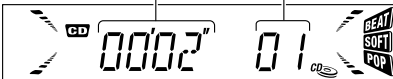

Note on One-Touch Operation:

When a CD is already in the loading slot, pressing CD turns on the unit and starts playback automatically.



Locating a track or a particular portion on a CD

To fast-forward or reverse the track

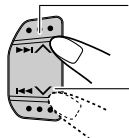

Press and hold **▶▶▲**, while playing a CD, to fast-forward the track.

Press and hold **◀◀▼**, while playing a CD, to reverse the track.

To go to the next tracks or the previous tracks

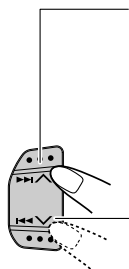

Press **▶▶▲** briefly, while playing a CD, to go ahead to the beginning of the next track. Each time you press the button consecutively, the beginning of the next tracks is located and played back.

Press **◀◀▼** briefly, while playing a CD, to go back to the beginning of the current track. Each time you press the button consecutively, the beginning of the previous tracks is located and played back.

To go to a particular track directly

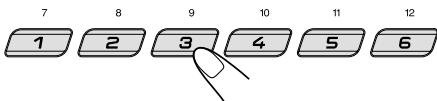

Press the number button corresponding to the track number to start its playback.

- To select a track number from 1 – 6:
Press 1 (7) – 6 (12) briefly.
- To select a track number from 7 – 12:
Press and hold 1 (7) – 6 (12) for more than 1 second.

Selecting CD playback modes

To play back tracks at random (Random Play)

You can play back all tracks on the CD at random. Each time you press MO RND (monaural/random) while playing a CD, CD random play mode turns on and off alternately.



The RND indicator

When the random mode is turned on, the RND indicator lights up on the display and a track randomly selected starts playing.



Prohibiting CD ejection

You can prohibit CD ejection and can lock a CD in the loading slot.

Press and hold CD and ▲ for more than 2 seconds.



"EJECT" flashes on the display for about 5 seconds, and the CD is locked and cannot be ejected.

To cancel the prohibition and unlock the CD, press and hold CD and ▲ again for more than 2 seconds, while pressing CD. "EJECT" appears on the display, and the CD ejects from the loading slot.



Adjusting the sound

You can adjust the sound characteristics to your preference.

1 Select the item you want to adjust.



Each time you press the button, the adjustable items change as follows:

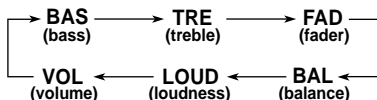

2 Adjust the level.

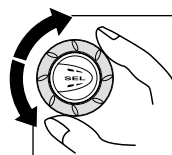

To increase the level.

To decrease the level.

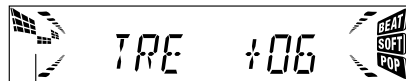

Equalization pattern changes as you adjust the bass or treble.

Note:

Normally the control dial works for volume adjustment. So you do not have to select "VOL" to adjust the volume level.

Using the Sound Control Memory (SCM)

You can select and store a preset sound adjustment suitable for each playback source.

(Advanced SCM)

Selecting and storing the sound modes

Once you select a sound mode, it is stored in memory. It will be recalled every time you select the same source and will be shown on the display. A sound mode can be stored for each of the following sources — FM1, FM2, FM3, AM and CD.

- If you do not want to store the sound mode separately for each playback source, but want to use the same sound mode for all the sources, see "To cancel Advanced SCM" on page 21.

Select the sound mode you want.



Each time you press the button, the sound mode changes as follows:

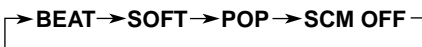

Indication	To do:	Range
BAS	Adjust the bass.	-06 (min.) +06 (max.)
TRE	Adjust the treble.	-06 (min.) +06 (max.)
FAD*	Adjust the front and rear speaker balance.	R06 (Rear only) F06 (Front only)
BAL	Adjust the left and right speaker balance.	L06 (Left only) R06 (Right only)
LOUD	Boost low and high frequencies to produce a well-balanced sound at low volume level.	LOUD ON LOUD OFF
VOL	Adjust the volume.	00 (min.) 50 (max.)

* If you are using a two-speaker system, set the fader level to "00."



- When “SCM LINK” is set to “LINK ON”, the selected sound mode can be stored in memory for the current source and the effect applies only to the current source. Each time you change the playback source, the SCM indicator flashes on the display.
- When “SCM LINK” is set to “LINK OFF”, the selected sound mode effect applies to any source.

Indication	For:	Preset values		
		BAS	TRE	LOUD
BEAT	Rock or disco music	+02	00	ON
SOFT	Quiet background music	+01	-03	OFF
POP	Light music	+04	+01	OFF
SCM OFF	(Flat sound)	00	00	ON

Recalling the sound modes

When “SCM LINK” is set to “LINK ON,” Select the source.

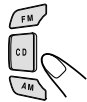

The sound mode stored in memory for the selected source is recalled.

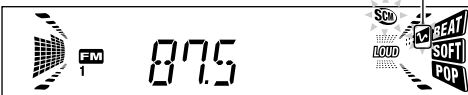

Notes:

- You can adjust each sound mode to your preference, and store it in memory.
If you want to adjust and store your original sound mode, see “Storing your own sound adjustments” on the right column.
- To adjust the bass and treble reinforcement levels or to turn on/off the loudness function temporarily, see page 17. (Your adjustments will be canceled if another source is selected.)

Storing your own sound adjustments

You can adjust the sound modes (BEAT, SOFT, POP) to your preference and store your own adjustments in memory.

- There is a time limit in doing the following procedure. If the setting is canceled before you finish, start from step 1 again.

1 Call up the sound mode you want to adjust.

- See the left column for details.



2 Select “BAS (Bass),” “TRE (Treble)” or “LOUD (Loudness).”



3 Adjust the bass or treble level or turn the loudness function ON/OFF.

- See page 17 for details.

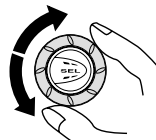

4 Repeat steps 2 and 3 to adjust the other items.

5 Press and hold SCM until the sound mode you have selected in step 1 flashes on the display.

Your adjustment made for the selected sound mode is stored in memory.



6 Repeat the same procedure to store other sound modes.

To reset to the factory settings

Repeat the same procedure and reassign the preset values listed in the table on the left column.

Setting the clock

You can also set the clock system either 24 hours or 12 hours.

- 1 Press and hold SEL (select) for more than 2 seconds so that one of the PSM items appears on the display. (See page 20.)



- 2 Set the hour.

- 1 Select "CLOCK H" if not shown on the display.
- 2 Adjust the hour.

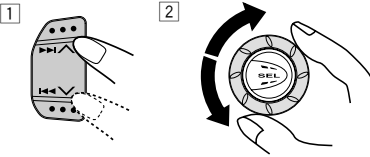

- 3 Set the minute.

- 1 Select "CLOCK M."
- 2 Adjust the minute.

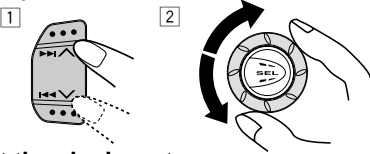

- 4 Set the clock system.

- 1 Select "24H/12H."
- 2 Select "24H" or "12H."

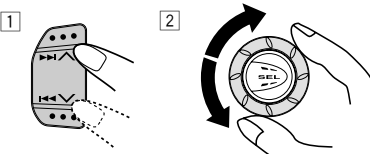

- 5 Finish the setting.



Changing the general settings (PSM)

You can change the items listed on the next page by using the PSM (Preferred Setting Mode) control.

Basic Procedure

- 1 Press and hold SEL (select) for more than 2 seconds so that one of the PSM items appears on the display. (See page 20.)



- 2 Select the PSM item you want to adjust. (See page 20.)

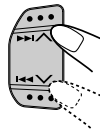

- 3 Adjust the PSM item selected above.

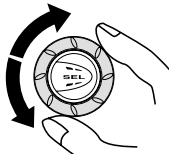

- 4 Repeat steps 2 and 3 to adjust the other PSM items if necessary.

- 5 Finish the setting.



To check the current clock time while the unit is turned off, press DISP (display). The power turns on, the clock time is shown for 5 seconds, then the power turns off.

Preferred Setting Mode (PSM) items

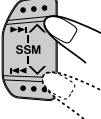
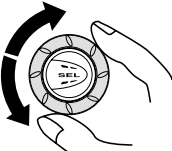
1		2		3		Factory-preset settings	See page
Hold.		Select.		Set.			
				Counter-clockwise			
				Clockwise			
CLOCK H	Hour adjustment	Back	Advance			0:00	19
CLOCK M	Minute adjustment	Back	Advance				
SCM LINK	Sound control memory linkage	LINK OFF	LINK ON			LINK ON	18, 21
24H/12H	24/12-hour time display	12H	24H			24H	19
AUTO ADJ	Automatic clock setting	OFF	ON			ON	13
DISPMODE	Display mode	PS NAME ↔ FREQ ↕ CLOCK ↕				PS NAME	13
PTY STBY	PTY standby	29 programme types (see page 11.)				NEWS	11
PTY SRCH	PTY search					(See page 11.)	11
TA VOL	Traffic announcement volume	VOL 00 – VOL 50				VOL 20	13
P-SEARCH	Programme search	OFF	ON			OFF	13
LEVEL	Level display	AUDIO 1 ↔ AUDIO 2 ↕ OFF ↕				AUDIO 2	21
TEL	Telephone muting	MUTING 1 ↔ MUTING 2 ↕ OFF ↕				OFF	21

- Press SEL (select) to finish the setting.

To cancel Advanced SCM – SCM LINK

You can cancel the Advanced SCM (Sound Control Memory), and unlink the sound modes and the playback sources.

When shipped from the factory, a different sound mode can be stored in memory for each source so that you can change the sound modes simply by changing the sources.

- **LINK ON:** Advanced SCM (different sound modes for different sources)
- **LINK OFF:** Conventional SCM (one sound mode for all sources)

To select the level meter – LEVEL

You can select the level display according to your preference.

When shipped from the factory, "AUDIO 2" is selected.

- **AUDIO 1:** Level meter illuminates from bottom to top.
- **AUDIO 2:** Alternates level meter (moves from bottom to top) and illumination display.
- **OFF:** Erases the audio level indicator.

To select the telephone muting – TEL

This mode is used when a cellular phone system is connected. Depending on the phone system used, select either "MUTING 1" or "MUTING 2," whichever mutes the sounds from this unit. When shipped from the factory, this mode is deactivated.

- **MUTING 1:** Select this if this setting can mute the sounds.
- **MUTING 2:** Select this if this setting can mute the sounds.
- **OFF:** Cancels the telephone muting.

Detaching the control panel

You can detach the control panel when leaving the car.

When detaching or attaching the control panel, be careful not to damage the connectors on the back of the control panel and on the panel holder.

Detaching the control panel

Before detaching the control panel, be sure to turn off the power.

1 Unlock the control panel.

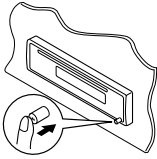

2 Pull the control panel out of the unit.

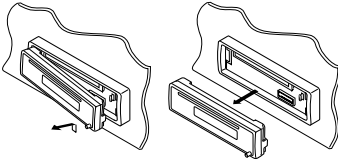

3 Put the detached control panel into the provided case.

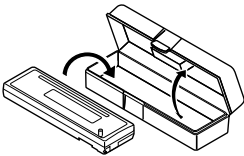

Attaching the control panel

1 Insert the left side of the control panel into the groove on the panel holder.

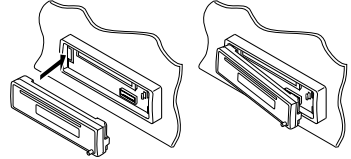

2 Press the right side of the control panel to fix it to the panel holder.

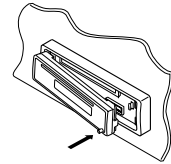

Note on cleaning the connectors:

If you frequently detach the control panel, the connectors will deteriorate.

To minimize this possibility, periodically wipe the connectors with a cotton swab or cloth moistened with alcohol, being careful not to damage the connectors.

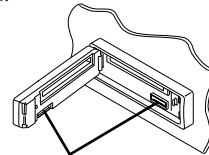

Connectors



Preparing the remote controller

(With an optionally purchased remote controller)
(only for KD-S811R)

We recommend that you use remote controller RM-RK31 with your unit. The followings are the instructions for using RM-RK31.

Before using the remote controller:

- Aim the remote controller directly at the remote sensor on the main unit. Make sure there is no obstacle in between.

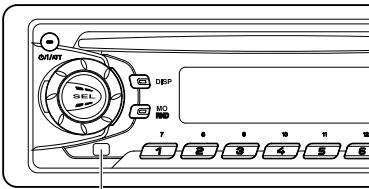

Remote sensor

- Do not expose the remote sensor to strong light (direct sunlight or artificial lighting).

Installing the battery

When the controllable range or effectiveness of the remote controller decreases, replace the battery.

1. Remove the battery holder.

- 1) Push out the battery holder in the direction indicated by the arrow using a ball-point pen or a similar tool.
- 2) Remove the battery holder.

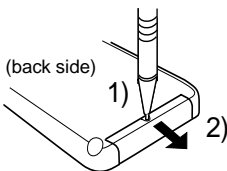

2. Place the battery.

Slide the battery into the holder with the + side facing upwards so that the battery is fixed in the holder.

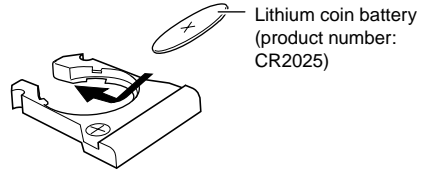

Lithium coin battery
(product number:
CR2025)

3. Return the battery holder.

Insert again the battery holder pushing it until you hear a clicking sound.

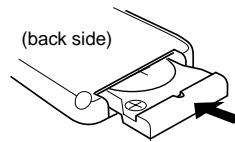

WARNING:

- Store the battery in a place where children cannot reach.
If a child accidentally swallows the battery, consult a doctor immediately.
- Do not recharge, short, disassemble or heat the battery or dispose it in a fire.
Doing any of these things may cause the battery to give off heat, crack or start a fire.
- Do not leave the battery with other metallic materials.
Doing this may cause the battery to give off heat, crack or start a fire.
- When throwing away or saving the battery, wrap it in tape and insulate; otherwise, the battery may start to give off heat, crack or start a fire.
- Do not poke the battery with tweezers or similar tools.
Doing this may cause the battery to give off heat, crack or start a fire.

Using the remote controller

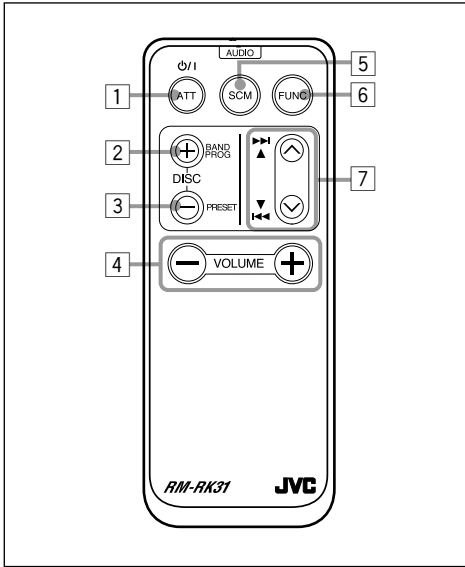

- 1 Functions the same as the ϕ /I/ATT button on the main unit.
- 2
 - Functions as the BAND button while listening to the radio. Each time you press the button, the band changes.
 - Does not function as the PROG/DISC + button.
- 3
 - Functions as the PRESET button while listening to the radio. Each time you press the button, the preset station number increases, and the selected station is tuned in.
 - Does not function as the DISC – button.
- 4 Functions the same as the control dial on the main unit.

Note: This button does not function for the preferred settings mode adjustment.
- 5 Selects the sound mode. Each time you press SCM (Sound Control Memory), the mode changes.
- 6 Selects the source. Each time you press FUNC (function), the source changes.
- 7
 - Searches stations while listening to the radio.
 - Fast forwards or reverses the track if pressed and held while listening to a CD.
 - Skips to the beginning of the next tracks or goes back to the beginning of the current (or previous tracks) if pressed briefly while listening to a CD.

TROUBLESHOOTING



What appears to be trouble is not always serious. Check the following points before calling a service center.

Symptoms	Causes	Remedies
• CD cannot be played back.	CD is inserted upside down.	Insert the CD correctly.
• CD sound is sometimes interrupted.	You are driving on rough roads.	Stop playing CD while driving on rough roads.
	The disc is scratched.	Change the disc.
	Connections are incorrect.	Check the cords and connections.
• Sound is sometimes interrupted.	Connections are incorrect.	Check the cords and connections.
• Sound cannot be heard from the speakers.	The volume is turned to the minimum level.	Adjust it to the optimum level.
	Connections are incorrect.	Check the cords and connections.
• SSM (Strong-station Sequential Memory) automatic preset does not work.	Signals are too weak.	Store stations manually.
• Static noise while listening to the radio.	The antenna is not connected firmly.	Connect the antenna firmly.
• "NO DISC" appears on the display.	No CD is inserted.	Insert a CD correctly.
• CD cannot be ejected.	CD is locked.	Unlock the CD (see page 16).
• CD can be neither played back nor ejected.	The unit may function incorrectly.	Press and hold both ⏏/ATT and ▲ at the same time for several seconds. Be careful not to drop CD when it is ejected.
• This unit does not work at all.	The built-in microcomputer may function incorrectly due to noise, etc.	Press and hold both SEL and ⏏/ATT at the same time for several seconds to reset the unit. (The clock setting and preset stations stored in memory are erased.) (See page 2.)



Handling CDs

This unit has been designed only to reproduce the CDs bearing the following marks.



- Other discs cannot be played back.

How to handle CDs

When removing a CD from its case, press down the center holder of the case and lift the CD out, holding it by the edges.

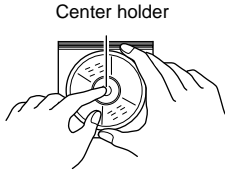

- Always hold the CD by the edges. Do not touch its recording surface.

When storing a CD into its case, gently insert the CD around the center holder (with the printed surface facing up).

- Make sure to store CDs into the cases after use.

To keep CDs clean

A dirty CD may not play correctly. If a CD does become dirty, wipe it with a soft cloth in a straight line from center to edge.

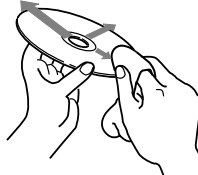

To play new CDs

New CDs may have some rough spots around the inner and outer edges. If such a CD is used, this unit may reject the CD.

To remove these rough spots, rub the edges with a pencil or ball-point pen, etc.

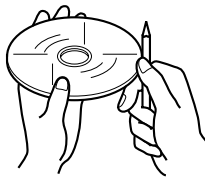

Moisture condensation

Moisture may condense on the lens inside the CD player in the following cases:

- After starting the heater in the car.
- If it becomes very humid inside the car.

Should this occur, the CD player may malfunction. In this case, eject the CD and leave the unit turned on for a few hours until the moisture evaporates.

When playing a CD-R (Recordable)

You can play back your original CD-Rs on this receiver.

- Before playing back CD-Rs, read their instructions or cautions carefully.
- Some CD-Rs recorded on CD recorders may not be played back on this receiver because of their disc characteristics, and of the following reasons:
 - Discs are dirty or scratched.
 - Moisture condensation occurs on the lens inside the unit.
 - The pickup lens inside the CD player is dirty.
- Use only “finalized” CD-Rs.
- CD-RWs (Rewritable) cannot be played back on this receiver.
- Do not use CD-Rs with stickers or sticking labels on the surface. They may cause malfunctions.

CAUTIONS:

- Do not insert 8 cm CDs (single CDs) into the loading slot. (Such CDs cannot be ejected.)
- Do not insert any CD of unusual shape — like a heart or flower; otherwise, it will cause a malfunction.
- Do not expose CDs to direct sunlight or any heat source or place them in a place subject to high temperature and humidity. Do not leave them in a car.
- Do not use any solvent (for example, conventional record cleaner, spray, thinner, benzene, etc.) to clean CDs.

About mistracking:

Mistracking may result from driving on extremely rough roads. This does not damage the unit and the CD, but will be annoying.

We recommend that you stop CD play while driving on such rough roads.

AUDIO AMPLIFIER SECTION

(For KD-S811R)

Maximum Power Output:

Front: 45 W per channel

Rear: 45 W per channel

Continuous Power Output (RMS):

Front: 17 W per channel into 4 Ω , 40 Hz to 20 000 Hz at no more than 0.8% total harmonic distortion.

Rear: 17 W per channel into 4 Ω , 40 Hz to 20 000 Hz at no more than 0.8% total harmonic distortion.

(For KD-S713R/KD-S711R)

Maximum Power Output:

Front: 40 W per channel

Rear: 40 W per channel

Continuous Power Output (RMS):

Front: 16 W per channel into 4 Ω , 40 Hz to 20 000 Hz at no more than 0.8% total harmonic distortion.

Rear: 16 W per channel into 4 Ω , 40 Hz to 20 000 Hz at no more than 0.8% total harmonic distortion.

Load Impedance: 4 Ω (4 Ω to 8 Ω allowance)

Tone Control Range:

Bass: ± 10 dB at 100 Hz

Treble: ± 10 dB at 10 kHz

Frequency Response: 40 Hz to 20 000 Hz

Signal-to-Noise Ratio: 70 dB

Line-Out Level/Impedance:

2.0 V/20 k Ω load (full scale)

Output Impedance: 1 k Ω

TUNER SECTION

Frequency Range:

FM: 87.5 MHz to 108.0 MHz

AM: (MW) 522 kHz to 1 620 kHz

(LW) 144 kHz to 279 kHz

[FM Tuner]

Usable Sensitivity: 11.3 dBf (1.0 μ V/75 Ω)

50 dB Quieting Sensitivity:

16.3 dBf (1.8 μ V/75 Ω)

Alternate Channel Selectivity (400 kHz):

65 dB

Frequency Response: 40 Hz to 15 000 Hz

Stereo Separation: 30 dB

Capture Ratio: 1.5 dB

[MW Tuner]

Sensitivity: 20 μ V

Selectivity: 35 dB

[LW Tuner]

Sensitivity: 50 μ V

CD PLAYER SECTION

Type: Compact disc player

Signal Detection System: Non-contact optical pickup (semiconductor laser)

Number of channels: 2 channels (stereo)

Frequency Response: 5 Hz to 20 000 Hz

Dynamic Range: 96 dB

Signal-to-Noise Ratio: 98 dB

Wow and Flutter: Less than measurable limit

GENERAL

Power Requirement:

Operating Voltage: DC 14.4 V

(11 V to 16 V allowance)

Grounding System: Negative ground

Allowable Operating Temperature: 0°C to +40°C

Dimensions (W \times H \times D):

Installation Size: 182 mm \times 52 mm \times 150 mm

Panel Size: 188 mm \times 58 mm \times 14 mm

Mass: 1.3 kg (excluding accessories)

Design and specifications subject to change without notice.

Having TROUBLE with operation?

Please reset your unit

Refer to page of How to reset your unit

Haben Sie PROBLEME mit dem Betrieb?

Bitte setzen Sie Ihr Gerät zurück

Siehe Seite Zurücksetzen des Geräts

Vous avez des PROBLÈMES de fonctionnement?

Réinitialisez votre appareil

Référez-vous à la page intitulée Comment réinitialiser votre appareil

Hebt u PROBLEMEN met de bediening?

Stel het apparaat terug

Zie de pagina met de paragraaf Het apparaat terugstellen

JVC

VICTOR COMPANY OF JAPAN, LIMITED



EN, GE, FR, NL



1100HISFLEJES

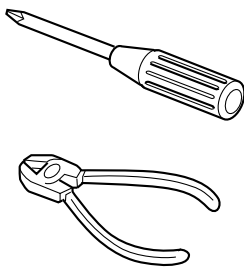

ENGLISH

- This unit is designed to operate on 12 V DC, NEGATIVE ground electrical systems.

INSTALLATION (IN-DASH MOUNTING)

- The following illustration shows a typical installation. However, you should make adjustments corresponding to your specific car. If you have any questions or require information regarding installation kits, consult your JVC IN-CAR ENTERTAINMENT dealer or a company supplying kits.

DEUTSCH

- Dieses Gerät ist für einen Betrieb in elektrischen Anlagen mit 12 V Gleichstrom und (-) Erdung ausgelegt.

EINBAU (IM ARMATURENBRETT)

- Die folgende Abbildung zeigt einen typischen Einbau. Dennoch müssen Sie entsprechend Ihrem jeweiligen Auto Anpassungen vornehmen. Bei irgendwelchen Fragen oder wenn Sie Informationen hinsichtlich des Einbausatzes brauchen, wenden Sie sich an ihren JVC Autoradiohändler oder ein Unternehmen das diese Einbausätze vertreibt.

FRANÇAIS

- Cet appareil est conçu pour fonctionner sur des sources de courant continu de 12 V à masse NEGATIVE seulement.

INSTALLATION (MONTAGE DANS LE TABLEAU DE BORD)

- L'illustration suivante est un exemple d'installation typique. Cependant, vous devez faire les ajustements correspondant à votre voiture particulière. Si vous avez des questions ou avez besoin d'information sur des kits d'installation, consulter votre revendeur d'autoradios JVC ou une compagnie d'approvisionnement.

1 Before mounting: Press (Control Panel Release button) to detach the control panel if already attached.

* When shipped from the factory, the control panel is packed in the hard case.

2 Remove the trim plate.

3 Remove the sleeve after disengaging the sleeve locks.

① Stand the unit.

Note: When you stand the unit, be careful not to damage the fuse on the rear.

② Insert the 2 handles between the unit and the sleeve, as illustrated, to disengage the sleeve locks.

③ Remove the sleeve.

Note: Be sure to keep the handles for future use after installing the unit.

4 Install the sleeve into the dashboard.

* After the sleeve is correctly installed into the dashboard, bend the appropriate tabs to hold the sleeve firmly in place, as illustrated.

5 Fix the mounting bolt to the rear of the unit's body and place the rubber cushion over the end of the bolt.

6 Do the required electrical connections.

7 Slide the unit into the sleeve until it is locked.

8 Attach the trim plate so that the projection on the trim plate is fixed to the left side of the unit.

9 Attach the control panel.

1 Vor dem Einbau: Drücken Sie (Freigabe der Bedienungsblende), um die Arretierung der Bedienungsblende zu lösen, sofern diese bereits angebracht ist.

* Bei der Auslieferung ab Werk ist die Bedienungsblende im Etui verpackt.

2 Den Frontrahmen herausnehmen.

3 Die Halterung nach dem Entriegeln der Halterungssperren abnehmen.

① Das Gerät aufstellen.

Hinweis: Beim Aufstellen des Geräts darauf achten, daß die Sicherung auf der Rückseite nicht beschädigt wird.

② Die 2 Griffe zwischen dem Gerät und der Halterung wie abgebildet einstecken und die Halterungssperren entriegeln.

③ Die Halterung entfernen.

Hinweis: Sicherstellen, daß die Griffe für künftigen Gebrauch nach dem Einbau des Geräts aufbewahrt werden.

4 Die Halterung im Armaturenbrett einbauen.

* Nach dem korrekten Einbau der Halterung im Armaturenbrett, die entsprechenden Riegel umknicken, um die Halterung an ihrem Platz zu sichern, siehe Abbildung.

5 Die Befestigungsschraube an der Rückseite des Gerätekörpers befestigen und das Ende der Schraube mit einem Gummipuffer abdecken.

6 Nehmen Sie die erforderlichen elektrischen Anschlüsse vor.

7 Das Gerät in die Halterung schieben, bis es einrastet.

8 Befestigen Sie die Frontrahmen in der Form, daß der Fortsatz der Frontrahmen auf der linken Seite des Geräts befestigt wird.

9 Die Schalttafel anbringen.

1 Avant le montage: Appuyez sur (déblocage du panneau de commande) pour éventuellement détacher le panneau de commande

* Lorsque ce panneau de commande sort d'usine, il est rangé dans un étui de transport.

2 Retirer la plaque d'assemblage.

3 Libérer les verrous du manchon et retirer le manchon.

① Poser l'appareil à la verticale.

Remarque: Lorsque vous mettez l'appareil à la verticale, faire attention de ne pas endommager le fusible situé sur l'arrière.

② Insérer les 2 poignées entre l'appareil et le manchon comme indiqué pour désengager les verrous de manchon.

③ Retirer le manchon.

Remarque: S'assurer de garder les poignées pour une utilisation ultérieure, après l'installation de l'appareil.

4 Installer le manchon dans le tableau de bord.

* Après installation correcte du manchon dans le tableau de bord, plier les bonnes pattes pour maintenir fermement le manchon en place, comme montré.

5 Monter le boulon de montage sur l'arrière du corps de l'appareil puis passer l'amortisseur en caoutchouc sur l'extrémité du boulon.

6 Réalisez les connexions électriques.

7 Faire glisser l'appareil dans le manchon jusqu'à ce qu'il soit verrouillé.

8 Attachez la plaque d'assemblage de façon que la projection de la plaque d'assemblage soit fixée sur le côté gauche de l'appareil.

9 Remonter le panneau de commande.

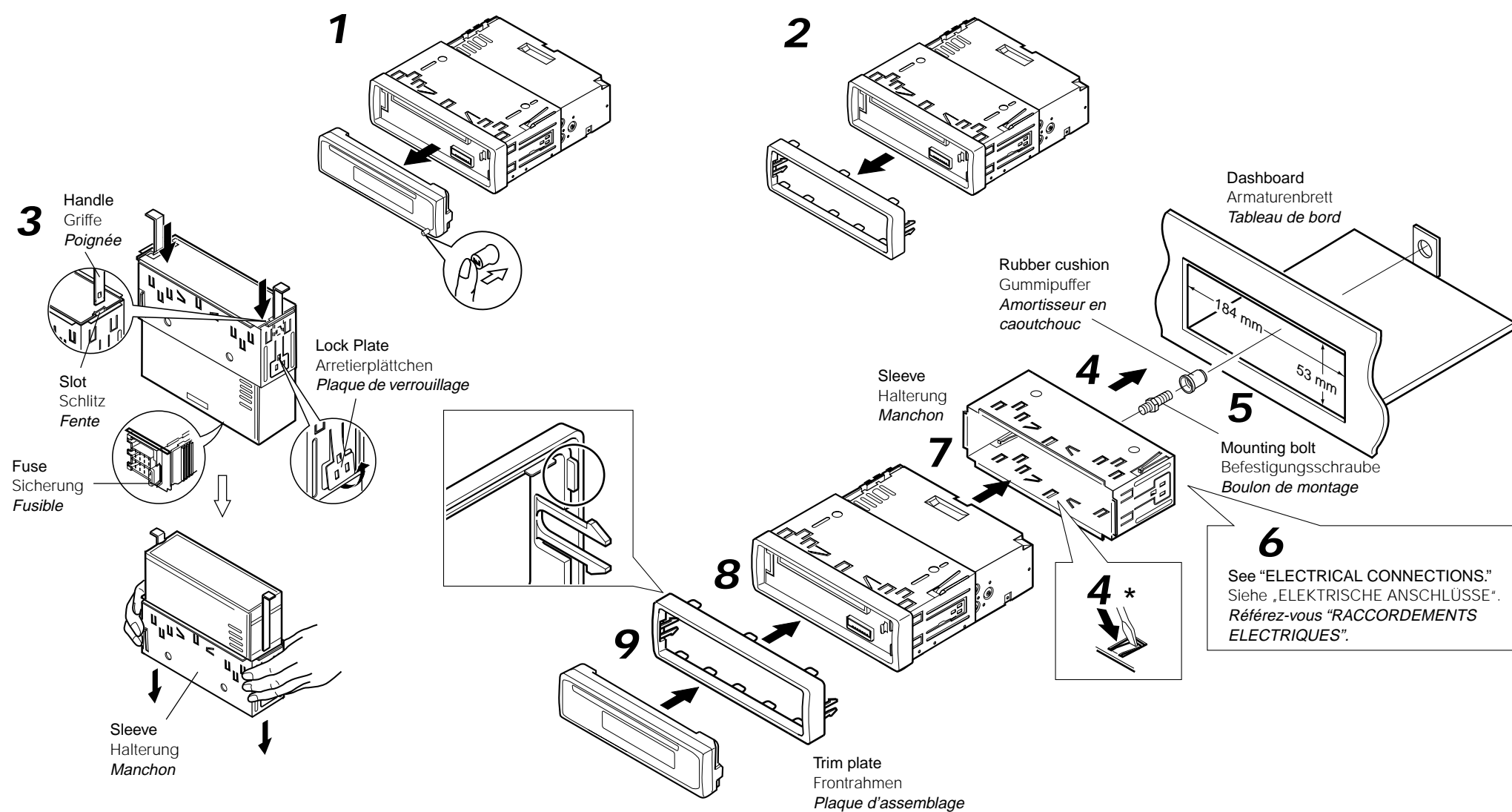

- When using the optional stay
- Beim Verwenden der Anker-Option
- Lors de l'utilisation du hauban en option

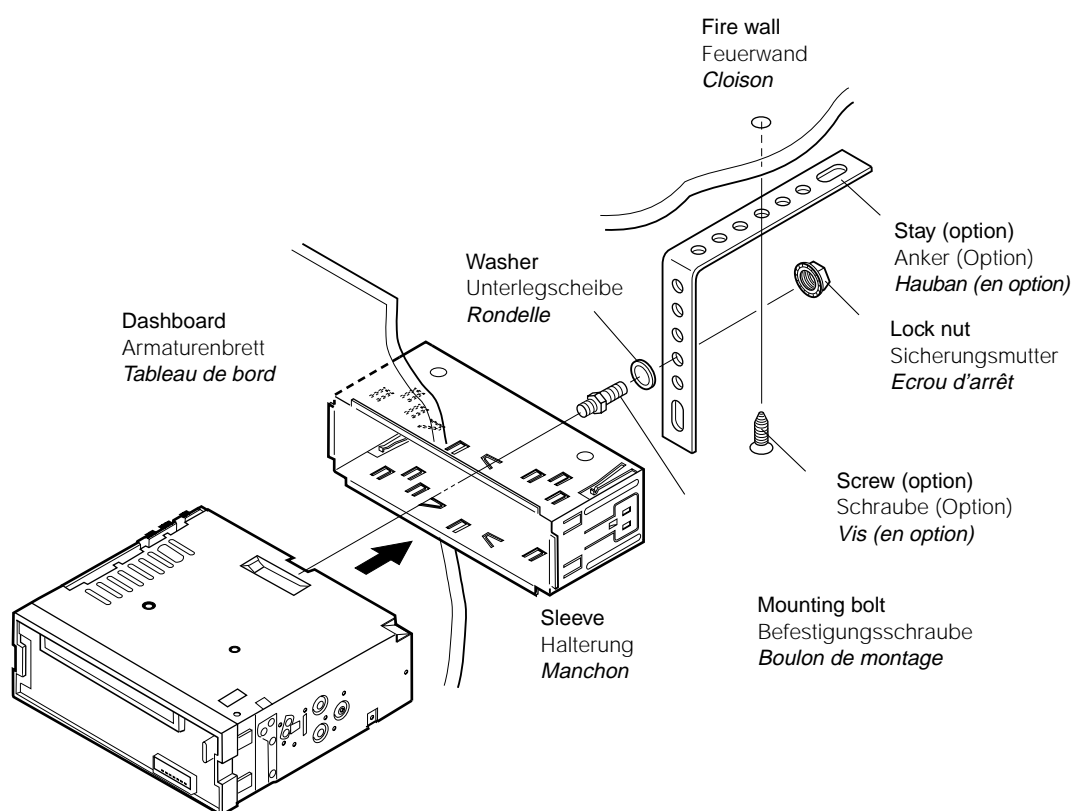

- When installing the unit without using the sleeve
- Beim Einbau des Geräts ohne Halterung
- Lors de l'installation de l'appareil sans utiliser de manchon

In a Toyota for example, first remove the car radio and install the unit in its place.
Zum Beispiel in einem Toyota zuerst das Autoradio ausbauen und dann das Gerät an seinem Platz einbauen.
Par exemple dans une Toyota, retirer d'abord l'autoradio et installer l'appareil à la place.

Flat type screws (M5 x 6 mm)*
Senkkopfschrauben (M5 x 6 mm)*
Vis à tête plate (M5 x 6 mm)*

* Not included with this unit.
* Nicht Teil dieses Geräts.
* Non fourni avec cet appareil.

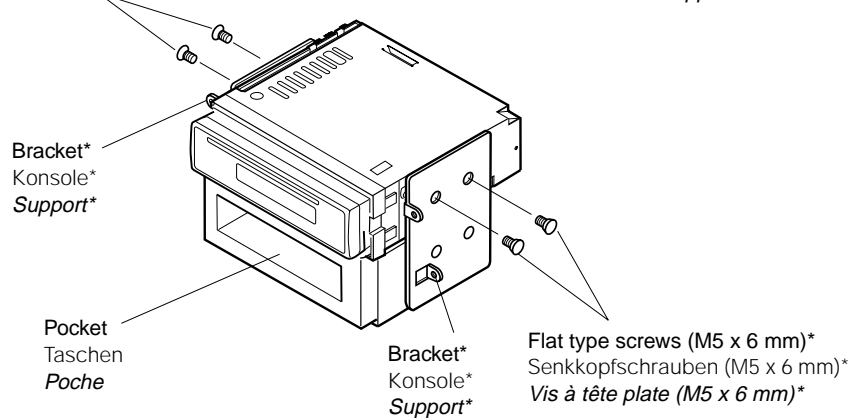

Note: When installing the unit on the mounting bracket, make sure to use the 6 mm-long screws. If longer screws are used, they could damage the unit.

Hinweis: Beim Anbringen des Gerät an der Konsole sicherstellen, daß 6 mm lange Schrauben verwendet werden. Werden längere Schrauben verwendet, können sie das Gerät beschädigen.

Remarque: Lors de l'installation de l'appareil sur le support de montage, s'assurer d'utiliser des vis d'une longueur de 6 mm. Si des vis plus longues sont utilisées, elles peuvent endommager l'appareil.

Removing the unit

- Before removing the unit, release the rear section.

- 1 Remove the control panel.
- 2 Remove the trim plate.
- 3 Insert the 2 handles into the slots, as shown. Then, while gently pulling the handles away from each other, slide out the unit. (Be sure to keep the handles after installing it.)

Ausbau des Geräts

- Vor dem Ausbau des Geräts den hinteren Teil freigeben.

- 1 Die Schalttafel herausnehmen.
- 2 Den Frontrahmen abnehmen.
- 3 Die 2 Griffe in die Schlitz wie gezeigt stecken. Dann die Griffe behutsam auseinander ziehen und das Gerät herausziehen. (Die Griffe nach dem Einbau auf jeden Fall aufbewahren.)

Retrait de l'appareil

- Avant de retirer l'appareil, libérer la section arrière.

- 1 Retirer le panneau de commande.
- 2 Retirer la plaque d'assemblage.
- 3 Introduire les deux poignées dans les fentes, comme montré. Puis, tout en tirant doucement les poignées écartées, faire glisser l'appareil pour le sortir. (S'assurer de conserver les poignées après l'installation de l'appareil.)

1

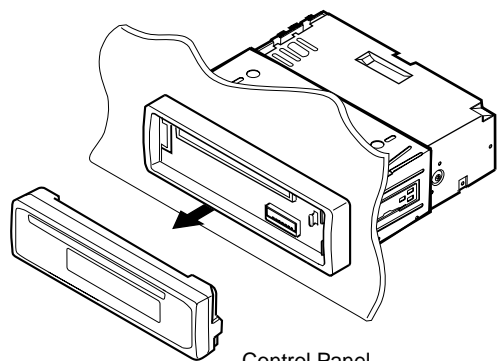

Control Panel
Schalttafel
Panneau de command

2

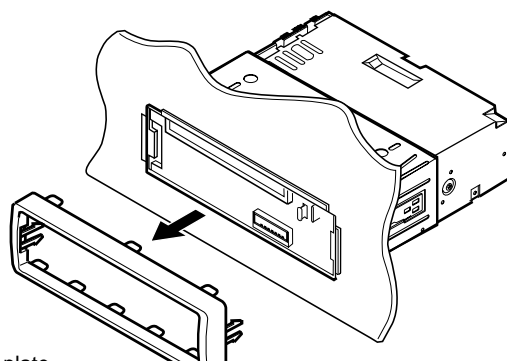

Trim plate
Frontrahmen
Plaque d'assemblage

3

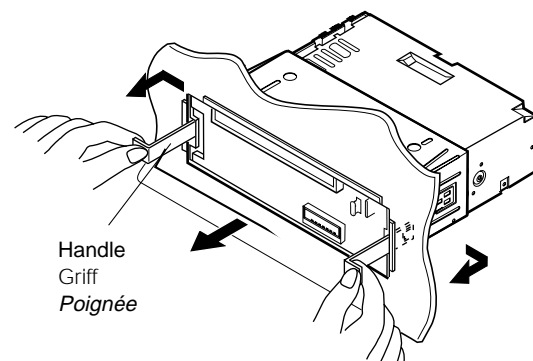

Handle
Griff
Poignée

Parts list for installation and connection

The following parts are provided with this unit.
After checking them, please set them correctly.

Hard case/Control Panel
Etui/Schalttafel
Etui de transport/Panneau de command

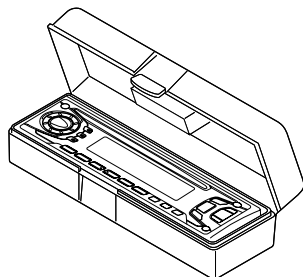

Sleeve
Halterung
Manchon

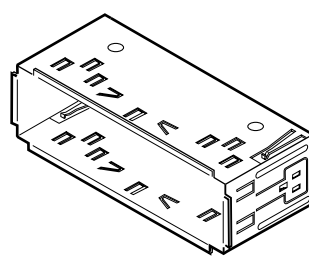

Trim plate
Frontrahmen
Plaque d'assemblage

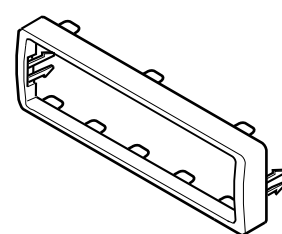

Power cord
Stromkabel
Cordon d'alimentation

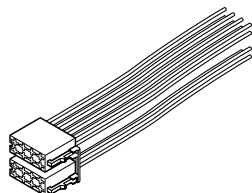

Handles
Griffe
Poignées



Washer (ø5)
Unterlegscheibe(ø5)
Rondelle (ø5)



Lock nut (M5)
Sicherungsmutter (M5)
Ecrou d'arrêt (M5)



Mounting bolt (M5 x 20 mm)
Befestigungsschraube (M5 x 20 mm)
Boulon de montage (M5 x 20 mm)



Rubber cushion
Gummipuffer
Amortisseur en caoutchouc



ELECTRICAL CONNECTIONS

ELEKTRISCHE ANSCHLÜSSE

RACCORDEMENTS ELECTRIQUES

To prevent short circuits, we recommend that you disconnect the battery's negative terminal and make all electrical connections before installing the unit. If you are not sure how to install this unit correctly, have it installed by a qualified technician.

Zur Vermeidung von Kurzschlüssen empfehlen wir, daß Sie den negativen Batterieanschluß abtrennen und alle elektrischen Anschlüsse herstellen, bevor das Gerät eingebaut wird. Sind Sie sich über den richtigen Einbau des Geräts nicht sicher, lassen Sie es von einem qualifizierten Techniker einbauen.

Pour éviter tout court-circuit, nous vous recommandons de débrancher la borne négative de la batterie et d'effectuer tous les raccordements électriques avant d'installer l'appareil. Si l'on n'est pas sûr de pouvoir installer correctement cet appareil, le faire installer par un technicien qualifié.

Note:
This unit is designed to operate on **12 V DC, NEGATIVE ground electrical systems.** If your vehicle does not have this system, a voltage inverter is required, which can be purchased at JVC IN-CAR ENTERTAINMENT dealers.

Hinweis:
Dieses Gerät ist für eine Betrieb in **elektrischen Anlagen mit 12 V Gleichstrom und (-) Erdung** ausgelegt. Verfügt Ihr Fahrzeug nicht über diese Anlage, ist ein Spannungsinverter erforderlich, der bei JVC Autoradiohändler erworben werden kann.

Remarque:
Cet appareil est conçu pour fonctionner sur des sources de courant continu de **12 V à masse NEGATIVE.** Si votre véhicule n'offre pas ce type d'alimentation, il vous faut un convertisseur de tension, que vous pouvez acheter chez un revendeur d'autoradios JVC.

- Replace the fuse with one of the specified rating. If the fuse blows frequently, consult your JVC IN-CAR ENTERTAINMENT dealer.
- If noise is a problem...
This unit incorporates a noise filter in the power circuit. However, with some vehicles, clicking or other unwanted noise may occur. If this happens, connect the unit's **rear ground terminal** (see connection diagram) to the car's chassis using shorter and thicker cords, such as copper braiding or gauge wire. If noise still persists, consult your JVC IN-CAR ENTERTAINMENT dealer.
- For KD-S811R – Maximum input of the speakers should be more than 45 W at the rear and 45 W at the front, with an impedance of **4 Ω to 8 Ω.**
- For KD-S713R/KD-S711R – Maximum input of the speakers should be more than 40 W at the rear and 40 W at the front, with an impedance of **4 Ω to 8 Ω.**
- **Be sure to ground this unit to the car's chassis.**
- The heat sink becomes very hot after use. Be careful not to touch it when removing this unit.

- Die Sicherung mit einer der entsprechenden Nennleistung ersetzen. Brennt die Sicherung häufig durch, wenden Sie sich an ihren JVC Autoradiohändler.
- Sind Störgeräusche ein Problem...
Dieses Gerät enthält ein Störfilter im Stromkreis. Bei manchen Fahrzeugen kann jedoch ein Klicken oder andere unerwünschte Störgeräusche auftreten. Sollte das der Fall sein, die **hintere Erdungscanschußklemme** (siehe Schaltplan) des Geräts am Fahrwerk des Fahrzeugs anschließen, dabei kürzere und dickere Kabel wie beispielsweise Kupfergeflechttraht oder Stahldraht verwenden. Bleibt Störgeräusch bestehen, wenden Sie sich an Ihren JVC Autoradiohändler.
- Für KD-S811R – Maximale Eingangsleistung der Lautsprecher muß höher als 45 W hinten und 45 W vorne sein, mit einer Impedanz von **4 Ω bis 8 Ω.**
- Für KD-S713R/KD-S711R – Maximale Eingangsleistung der Lautsprecher muß höher als 40 W hinten und 40 W vorne sein, mit einer Impedanz von **4 Ω bis 8 Ω.**
- **Sicherstellen, daß das Gerät am Fahrwerk geerdet wird.**
- Das Abstrahlblech wird nach dem Gebrauch sehr heiß. Beim Ausbau des Geräts darauf achten, das Abstrahlblech nicht zu berühren.

- Remplacer le fusible par un de la valeur précisée. Si le fusible saute souvent, consulter votre revendeur d'autoradios JVC.
- Si le bruit est un problème...
Cet appareil incorpore un filtre de bruit dans le circuit d'alimentation. Cependant, avec certains véhicules, quelques claquements ou autres bruits non désirés risquent de se produire. Si cela arrive, raccorder la **borne arrière de masse** de l'appareil au châssis de la voiture (voir le diagramme de raccordement) en utilisant des cordons les plus gros et les plus courts possibles telle qu'une barre de cuivre ou une tresse. Si le bruit persiste, consulter votre revendeur d'autoradios JVC.
- Pour KD-S811R – La puissance admissible des haut-parleurs doit être supérieure à 45 W à l'arrière et à 45 W l'avant, avec une impédance de **4 Ω à 8 Ω.**
- Pour KD-S713R/KD-S711R – La puissance admissible des haut-parleurs doit être supérieure à 40 W à l'arrière et à 40 W l'avant, avec une impédance de **4 Ω à 8 Ω.**
- **S'assurer de raccorder la mise à la masse de cet appareil au châssis de la voiture.**
- Le dissipateur de chaleur devient très chaud après usage. Faire attention de ne pas le toucher en retirant cet appareil.

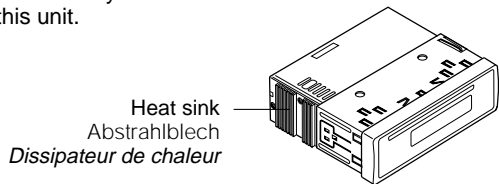

A Typical Connections / Typische Anschlüsse / Raccordements typiques

Before connecting: Check the wiring in the vehicle carefully. Incorrect connection may cause serious damage to this unit.

1 Connect the colored leads of the power cord to the car battery, speakers and power aerial (if any) in the following sequence.

- 1 Black: ground
- 2 Yellow: to car battery (constant 12 V)
- 3 Red: to an accessory terminal
- 4 Blue with white stripe: to power aerial (200 mA max.)
- 5 Brown: to cellular phone system (For details, refer to the instructions of the cellular phone.)
- 6 Others: to speakers

2 Connect the aerial cord.

3 Finally connect the wiring harness to the unit.

Note: If your vehicle does not have any accessory terminal, move the fuse from the fuse position 1 (initial position) to fuse position 2, and connect the red lead (A7) to the positive (+) battery terminal.

- The yellow lead (A4) is not used in this case.

Vor dem Anschließen: Die Verdrahtung im Fahrzeug sorgfältig überprüfen. Falsche Anschlüsse können ernsthafte Schäden am Gerät hervorrufen.

1 Die farbigen Leitungen des Spannungsversorgungskabels an der Autobatterie, den Lautsprechern und dem Motorantenne (sofern vorhanden) in folgender Reihenfolge anschließen.

- 1 Schwarz: Erdung
- 2 Gelb: an Autobatterie (konstant 12 V)
- 3 Rot: an Zubehörschußklemme
- 4 Blau mit weißem Streifen: an Motorantenne (max. 200 mA)
- 5 Braun: an Mobiltelefon (Weitere Informationen entnehmen Sie bitte der Bedienungsanleitung des Mobiltelefons.)
- 6 Andere: an Lautsprecher

2 Das Antennenkabel anschließen.

3 Die Kabelbäume am Gerät anschließen.

Hinweis: Verfügt Ihr Fahrzeug nicht über eine Zubehörschußklemme, die Sicherung von der 1. Sicherungsposition (Erstposition) in die 2. Sicherungsposition versetzen, die rote Leitung (A7) an der (+) Batterieanschlußklemme anschließen.

- Die gelbe Leitung (A4) wird in diesem Fall nicht verwendet.

Avant de commencer la connexion: vérifiez attentivement le câblage du véhicule. Une connexion incorrecte peut endommager sérieusement l'appareil.

1 Connectez les fils de couleur du cordon d'alimentation à la batterie de la voiture, aux enceintes et à l'antenne automatique (s'il y en a une) dans l'ordre suivant.

- 1 Noir: a la masse
- 2 Jaune: a la batterie de la voiture (12 V constant)
- 3 Rouge: à la prise accessoire
- 4 Bleu avec bande blanche: à l'antenne automatique (200 mA max.)
- 5 Marron: à un système de téléphone cellulaire (Pour les détails, se référer aux instructions du téléphone cellulaire.)
- 6 Autres: aux enceintes

2 Connectez le cordon d'antenne.

3 Finalement, connectez le faisceau de fils à l'appareil.

Remarque: Si votre véhicule ne possède pas de borne accessoire, déplacez le fusible de la position de fusible 1 (position originale) à la position de fusible 2 et connectez le fil rouge (A7) à la borne positive (+) de la batterie.

- Le fil jaune (A4) n'est pas utilisé dans ce cas.

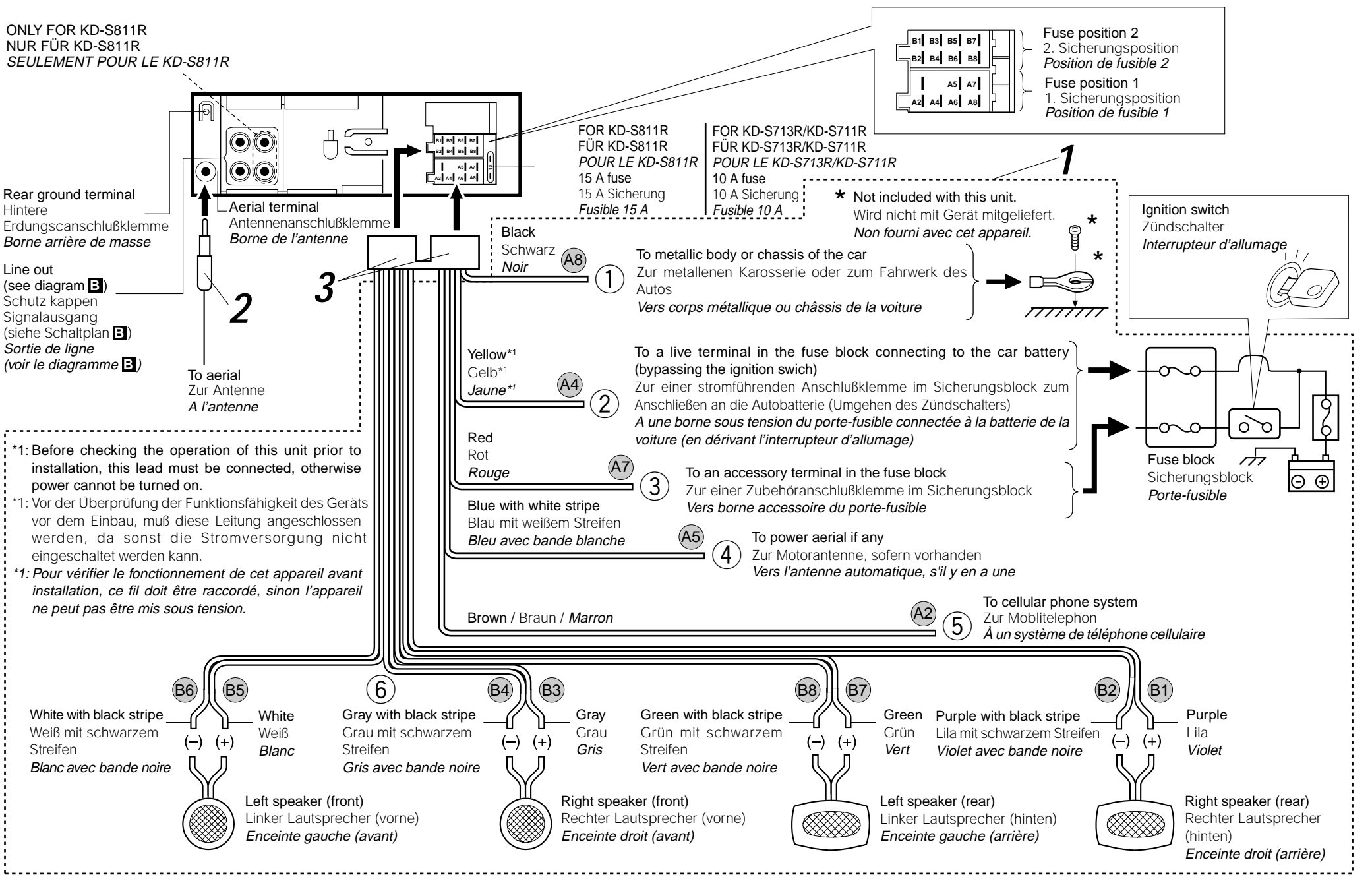

PRECAUTIONS on power supply and speaker connections:

- **DO NOT** connect the speaker leads of the power cord to the car battery; otherwise, the unit will be seriously damaged.
- Connect the black lead (ground), yellow lead (to car battery, constant 12 V), and red lead (to an accessory terminal) correctly.
- **BEFORE** connecting the speaker leads of the power cord to the speakers, check the speaker wiring in your car.
 - If the speaker wiring in your car is as illustrated in Fig. 1 and Fig. 2 below, **DO NOT** connect the unit using that original speaker wiring. If you do, the unit will be seriously damaged. Redo the speaker wiring so that you can connect the unit to the speakers as illustrated in Fig. 3.
 - If the speaker wiring in your car is as illustrated in Fig. 3, you can connect the unit using the original speaker wiring in your car.
 - If you are not sure of the speaker wiring of your car, consult your car dealer.

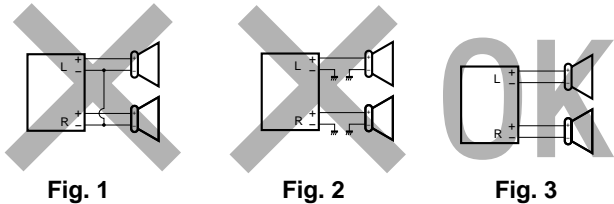

VORSICHTSMASSELN beim Anschließen der Stromversorgung und Lautsprecher:

- Die Lautsprecherleitungen des Netzkabels **NICHT** an der Autobatterie anschließen, da sonst das Gerät schwer beschädigt wird.
- Die schwarze Leitung (Erdung), die gelbe Leitung (zur Autobatterie, konstant 12 V) und die rote Leitung (zur Zubehöranschlusßklemme) richtig anschließen.
- **VOR** dem Anschließen der Lautsprecherleitungen des Spannungsversorgungskabels an die Lautsprecher, die Lautsprecherverdrahtung in Ihrem Auto überprüfen.
 - Ist die Lautsprecherverdrahtung wie unten in "Fig. 1" und "Fig. 2" abgebildet, das Gerät **NICHT** mit der Originalverdrahtung der Lautsprecher anschließen, da sonst das Gerät schwer beschädigt wird. Die Lautsprecherverdrahtung erneuern, so daß Sie das Gerät an den Lautsprechern wie in "Fig. 3" abgebildet anschließen können.
 - Ist die Lautsprecherverdrahtung in Ihrem Auto wie in "Fig. 3" abgebildet, können Sie das Gerät mit der Originalverdrahtung der Lautsprecher in Ihrem Auto anschließen.
 - Sind Sie sich über die Lautsprecherverdrahtung in Ihrem Auto nicht sicher, wenden Sie sich an Ihren Autohändler.

PRECAUTIONS sur l'alimentation et la connexion des enceintes:

- **NE CONNECTEZ PAS** les fils d'enceintes du cordon d'alimentation à la batterie; sinon, l'appareil serait sérieusement endommagé.
- Connectez correctement le fil noir (à la masse), le fil jaune (à la batterie de la voiture, 12 V constant) et le fil rouge (à la prise accessoire).
- **AVANT** de connecter les fils d'enceintes du cordon d'alimentation aux enceintes, vérifiez le câblage des enceintes de votre voiture.
 - Si le câblage des enceintes de votre voiture est réalisé comme montré sur la Fig. 1 ou Fig. 2 ci-dessous, **NE CONNECTEZ PAS** l'appareil en utilisant ce câblage original d'enceintes. Si vous le faites, l'appareil sera sérieusement endommagé. Recommencez le câblage des enceintes de façon que vous puissiez connecter l'appareil aux enceintes comme montré sur la Fig. 3.
 - Si le câblage des enceintes de votre voiture est comme montré sur la Fig. 3, vous pouvez connecter l'appareil en utilisant ce câblage original d'enceintes pour votre voiture.
 - Si vous n'êtes pas sûrs du câblage d'enceintes de votre voiture, consulter le concessionnaire de votre voiture.

Connecting the leads / Anschließen der Leitungen / Raccordement des fils

Twist the core wires when connecting. Die Kerndrähte beim Anschließen verdrehen. Torsader les âmes des fils en les raccordant.

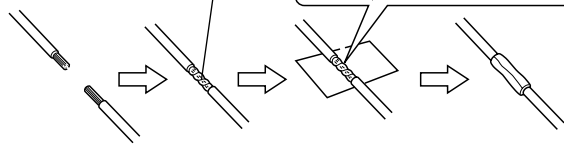

Solder the core wires to connect them securely. Die Kerndrähte anlöten, um sie fest anzuschließen. Souder les âmes des fils pour les raccorder entre eux de façon sûre.

CAUTION / VORSICHT / PRECAUTION:

- To prevent short-circuit, cover the terminals of the **UNUSED** leads with insulating tape.
- Zur Vermeidung eines Kurzschlusses die Anschlußklemmen der **NICHT VERWENDETEN** Leitungen mit Isolierklebeband umwickeln.
- Pour éviter les court-circuits, couvrir les bornes des fils qui ne sont **PAS** utilisés avec de la bande isolante.

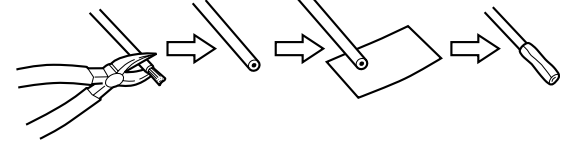

B Connections Adding Other Equipment / Anschlüsse zum Hinzufügen von anderer Ausrüstung / Raccordement pour ajouter d'autres appareils

Amplifier / Verstärker / Amplificateur

- You can connect an amplifier to upgrade your car stereo system.
- Connect the remote lead (blue with white stripe) to the remote lead of the other equipment so that it can be controlled through this unit.
 - For amplifier only:
 - Connect this unit's line-out terminals to the amplifier's line-in terminals.
 - **Disconnect the speakers from this unit, connect them to the amplifier. Leave the speaker leads of this unit unused. (Cover the terminals of these unused leads with insulating tape, as illustrated above.)**

- Sie können einen Verstärker anschließen, um Ihre Autostereoanlage zu erweitern.
- Schließen Sie das Fernbedienungskabel (blau mit weißem Streifen) an das Fernbedienungskabel des anderen Geräts an, so daß es über dieses Gerät gesteuert werden kann.
 - Nur für den Verstärker:
 - Die Anschlußklemmen am Ausgang dieses Gerät an den Anschlußklemmen des Eingangs des Verstärkers anschließen.
 - **Die Lautsprecher von diesem Gerät abtrennen und am Verstärker anschließen. Die Lautsprecherleitungen dieses Geräts unbenutzt lassen. (Die Anschlußklemmen dieser nicht verwendeten Leitungen mit Isolierklebeband umwickeln, siehe Abbildung oben.)**

- Vous pouvez connecter un amplificateur pour améliorer votre système autoradio.
- Connectez le fil de commande à distance (bleu avec bande blanche) au fil de commande à distance de l'autre appareil de façon qu'il puisse être commandé via cet appareil.
 - Pour l'amplificateur seulement:
 - Raccorder les bornes de sortie ligne de cet appareil aux bornes d'entrée ligne de l'amplificateur.
 - **Déconnectez les enceintes de cet appareil et connectez-les à l'amplificateur. Laissez les fils d'enceintes de cet appareil inutilisés. (Recouvrir les extrémités de ces fils inutilisés avec de la bande isolante comme montré ci-dessus.)**

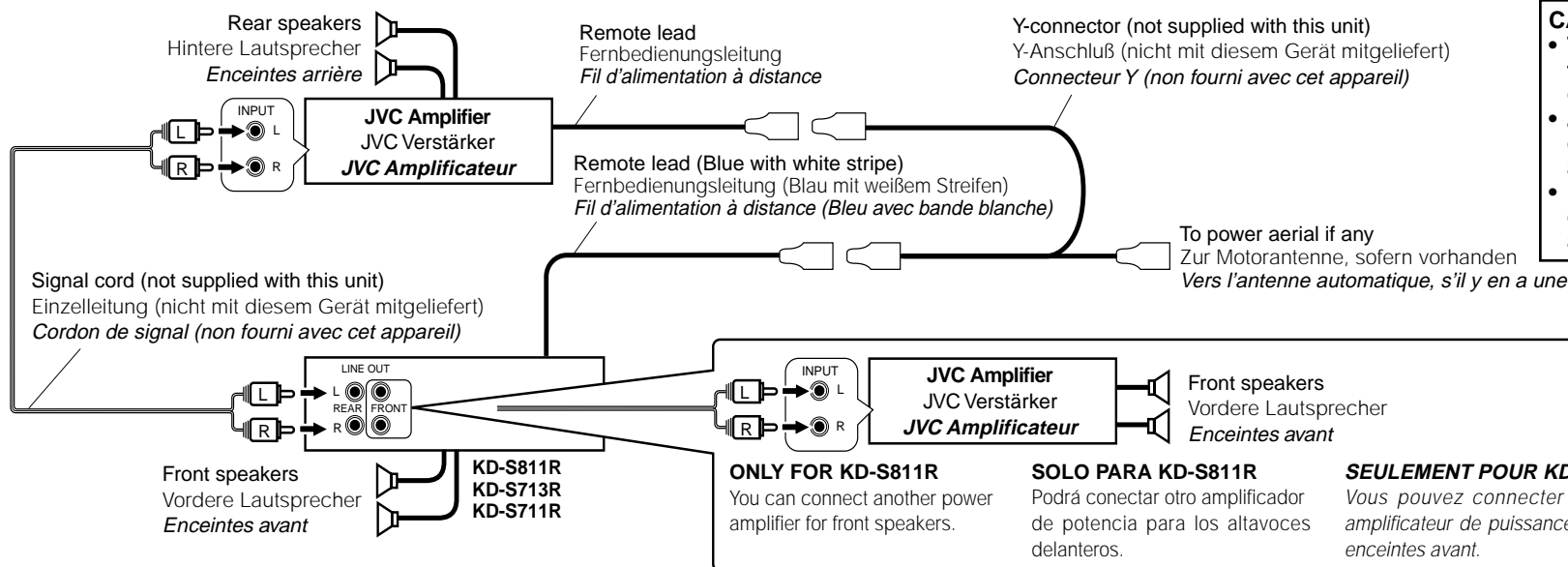

CAUTION / VORSICHT / PRECAUTION:

- To prevent internal heat buildup inside this unit, place this unit **UNDER** the other equipment.
- Zur Vermeidung eines Hitzestaus in diesem Gerät, dieses Gerät **UNTER** die andere Geräteansüstung stellen.
- Pour éviter un échauffement interne de cet appareil, placez-le **SOUS** l'autre appareil.

TROUBLESHOOTING

- **The fuse blows.**
 - * Are the red and black leads connected correctly?
- **Power cannot be turned on.**
 - * Is the yellow lead connected?
- **No sound from the speakers.**
 - * Is the speaker output lead short-circuited?
- **Sound is distorted.**
 - * Is the speaker output lead grounded?
 - * Are the "-" terminals of L and R speakers grounded in common?
- **Unit becomes hot.**
 - * Is the speaker output lead grounded?
 - * Are the "-" terminals of L and R speakers grounded in common?

FEHLERSUCHE

- **Die Sicherung brennt durch.**
 - * Sind die roten und schwarzen Leitungen richtig angeschlossen?
- **Stromversorgung kann nicht eingeschaltet werden.**
 - * Ist die gelbe Leitung angeschlossen?
- **Kein Ton aus den Lautsprechern.**
 - * Ist die Lautsprecherausgangsleitung kurzgeschlossen?
- **Ton verzerrt.**
 - * Ist die Lautsprecherausgangsleitung geerdet?
 - * Sind die (-) Anschlußklemmen der linken und rechten Lautsprecher zusammen geerdet?
- **Gerät wird heiß.**
 - * Ist die Lautsprecherausgangsleitung geerdet?
 - * Sind die (-) Anschlußklemmen der linken und rechten Lautsprecher zusammen geerdet?

EN CAS DE DIFFICULTÉS

- **Le fusible saute.**
 - * Les fils rouge et noir sont-ils raccordés correctement?
- **L'appareil ne peut pas être mise sous tension.**
 - * Le fil jaune est-elle raccordée?
- **Pas de son des haut-parleurs.**
 - * Le fil de sortie de enceinte est-il court-circuité?
- **Le son est déformé.**
 - * Le fil de sortie de enceinte est-il à la masse?
 - * Les bornes "-" des enceintes gauche et droit sont-elles mises ensemble à la masse?
- **L'appareil devient chaud.**
 - * Le fil de sortie de enceinte est-il à la masse?
 - * Les bornes "-" des enceintes gauche et droit sont-elles mises ensemble à la masse?